

DL SERIES for STANDARD

2.3mm (090)

Structure / 構造

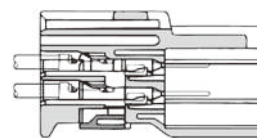
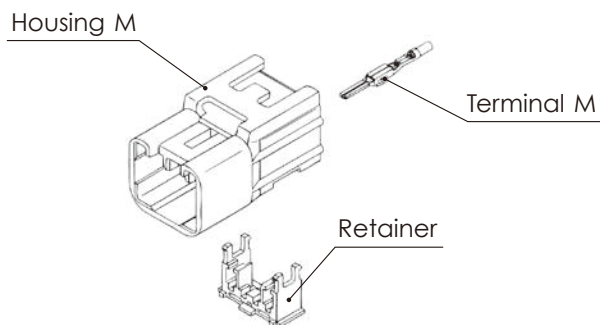

Retainer sliding direction

リテーナを押込むことにより、端子の半挿入状態を検知できます。

Connector M

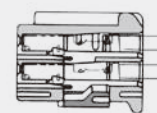
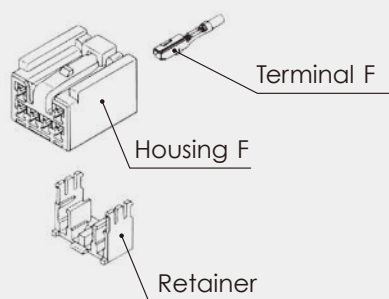

Retainer sliding direction

リテーナを押込むことにより、端子の半挿入状態を検知できます。

Connector F

K-07

DL SERIES

2.3mm (090)

Terminal (UNIT : mm)

Ref: 2.3mm Terminal detail
2.3mmターミナル参照頁

S M (8230-4492) A-10 **F** (8240-4882) A-10

M M (8230-4502) A-10 **F** (8240-4892) A-10

L M (8230-4512) A-10 **F** (8240-4942) A-10

Regarding "Gold-plated Terminal", please refer "A-10".
AuメッキターミナルはA-10ご参照

2.3mm (090)

Housing (UNIT : mm)

Ref: Terminal part No.
ターミナル参照頁 A-10

Material Low water absorption
材質 Nylon

2way

Color 色相 Natural 自然色

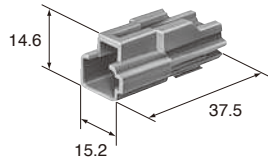

M (6249-1248)

F (6249-1251)

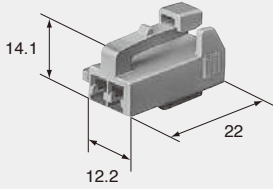

Color 色相 Natural 自然色

4way

Color 色相 Natural 自然色

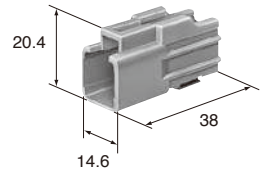

M (6249-1249)

F (6249-1252)

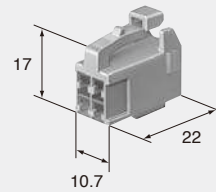

Color 色相 Natural 自然色

6way

Color 色相 Natural 自然色

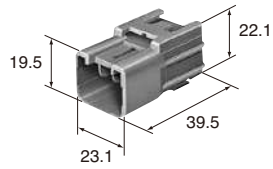

M (6249-1250)

F (6249-1253)

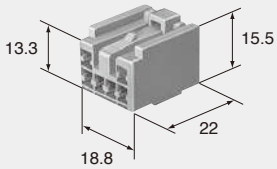

Color 色相 Natural 自然色

10way

F (6248-5311)

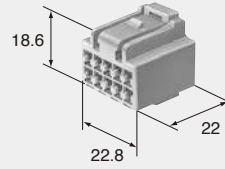

Color 色相 Natural 自然色

14way

Color 色相 Natural 自然色

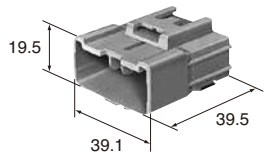

M (6249-1265)

F (6248-5309)

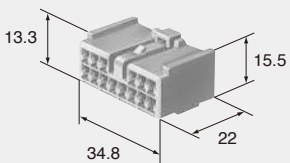

Color 色相 Natural 自然色

16way

Color 色相 Natural 自然色

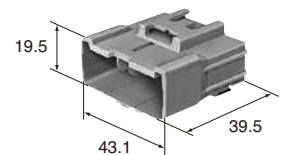

M (6249-1266)

F (6248-5310)

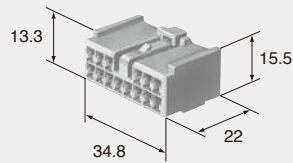

Color 色相 Natural 自然色

K-08