

SL SERIES for STANDARD

1.5mm (060)

Structure / 構造

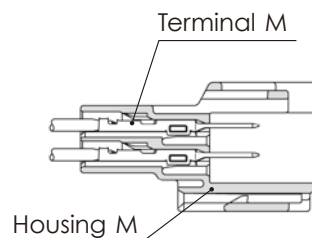
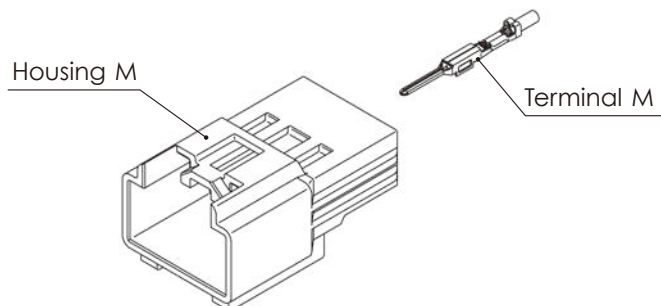

I-02

Connector M

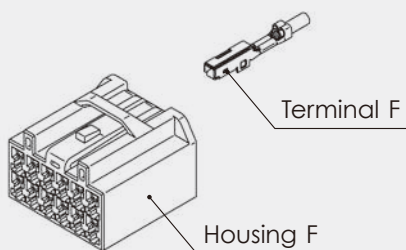

Connector F

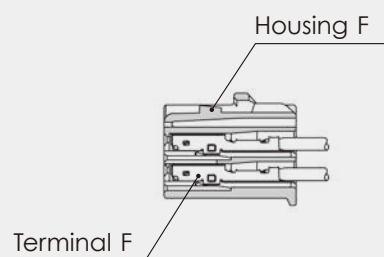

1.5mm (060)

Terminal (UNIT : mm)

Note) L size terminal can be used for 14 poled connectors with insertion cavity specified.
For details please contact our sales staff.

※Lサイズターミナルの使用できるコネクタは限定されます。
必ず弊社営業担当にお問い合わせください。

(S)

Cable size (mm ²) 適用電線サイズ	0.3~0.5
Material 材質	Heat-resistant copper alloy
Surface treatment 表面処理	Tin-plated Snメッキ

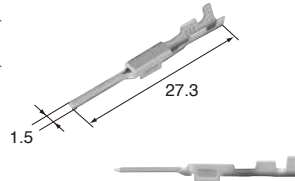
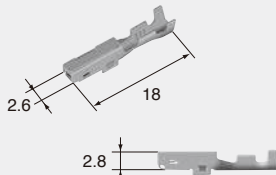
**M (8100-3382)**

Cable size (mm ²) 適用電線サイズ	0.3~0.5
Material 材質	Heat-resistant copper alloy
Surface treatment 表面処理	Tin-plated Snメッキ

F (8100-3391)**(S)**

Cable size (mm ²) 適用電線サイズ	0.3~0.5
Material 材質	Heat-resistant copper alloy
Surface treatment 表面処理	Gold-plated Auメッキ

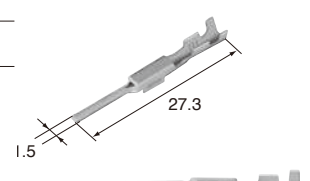
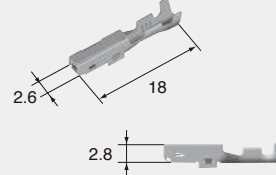
**M (8230-4883)**

Cable size (mm ²) 適用電線サイズ	0.3~0.5
Material 材質	Heat-resistant copper alloy
Surface treatment 表面処理	Gold-plated Auメッキ

F (8240-0135)**(M)**

Cable size (mm ²) 適用電線サイズ	0.75, 0.85~1.25
Material 材質	Heat-resistant copper alloy
Surface treatment 表面処理	Tin-plated Snメッキ

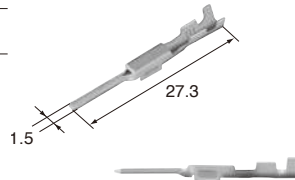
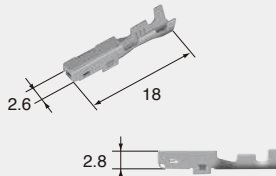
**M (8100-3383)**

Cable size (mm ²) 適用電線サイズ	0.75, 0.85~1.25
Material 材質	Heat-resistant copper alloy
Surface treatment 表面処理	Tin-plated Snメッキ

F (8100-3392)**(L)**

Cable size (mm ²) 適用電線サイズ	2.0
Material 材質	Heat-resistant copper alloy
Surface treatment 表面処理	Tin-plated Snメッキ

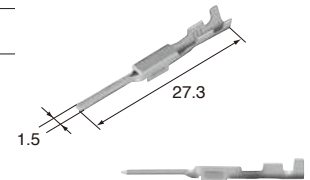
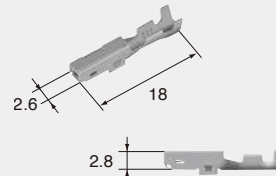
**M (8100-3384)**

Cable size (mm ²) 適用電線サイズ	2.0
Material 材質	Heat-resistant copper alloy
Surface treatment 表面処理	Tin-plated Snメッキ

F (8100-3393)**1.5mm (060)****Housing** (UNIT : mm)

Ref: Terminal part No. I-02
ターミナル参照頁

Material PBT
材質

Note) Connector can be used together with 2mm² wire are 14 poled connectors.
For details of each product, please contact our sales staff.

※Lサイズターミナルの使用できるコネクタは限定されます。
必ず弊社営業担当にお問い合わせください。

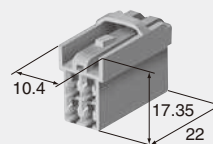
4way**F (6098-3456)**

Color 色相 Natural 自然色

I-03

SL SERIES

12way

Color Natural
色 相 自然色

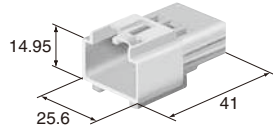

M (6098-3449)

F (6098-8482)

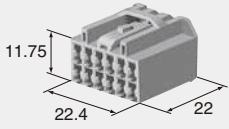

Color Natural
色 相 自然色

12way

F (6098-4876)

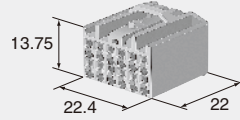

Color Natural
色 相 自然色

14way

F (6098-4877)

Note)

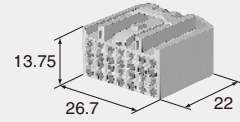

Color Natural
色 相 自然色

16way

F (6098-3453)

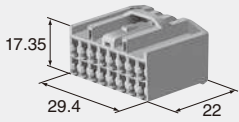

Color Natural
色 相 自然色