

TS SERIES for STANDARD

2.3mm (090)

A-10

Structure / 構造

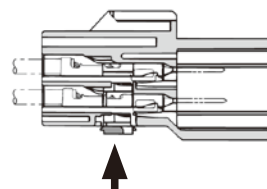
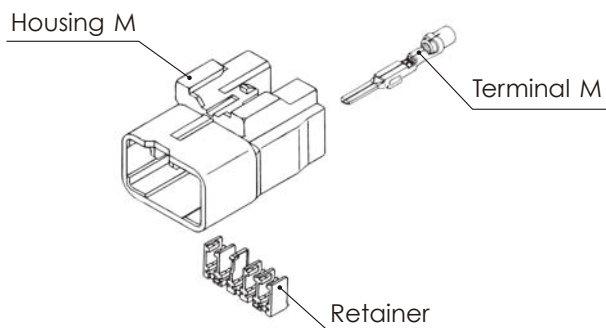

Retainer sliding direction

リテーナを押込むことにより、端子の半挿入状態を検知できます。

Connector M

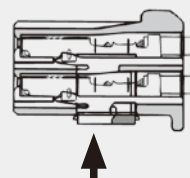
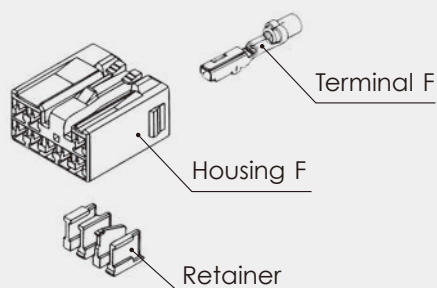

Retainer sliding direction

リテーナを押込むことにより、端子の半挿入状態を検知できます。

Connector F

2.3mm (090)

Terminal (UNIT : mm)

(SS)

Cable size (mm ²) 適用電線サイズ	0.22~0.35
Material 材質	Brass 黄銅
Surface treatment 表面処理	Tin-plated Snメッキ

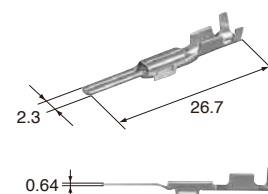

M (8230-4742)

F (8240-0029)

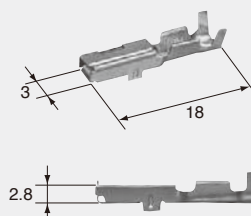

Cable size (mm ²) 適用電線サイズ	0.22~0.35
Material 材質	Brass 黄銅
Surface treatment 表面処理	Tin-plated Snメッキ

(S)

Cable size (mm ²) 適用電線サイズ	0.3~0.5
Material 材質	Brass 黄銅
Surface treatment 表面処理	Tin-plated Snメッキ

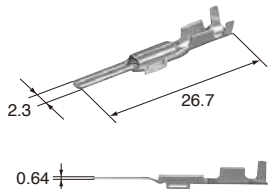
**M (8230-4492)****F (8240-4882)****(S)****Au**

Cable size (mm ²) 適用電線サイズ	0.3~0.5
Material 材質	Brass 黄銅
Surface treatment 表面処理	Gold-plated Auメッキ

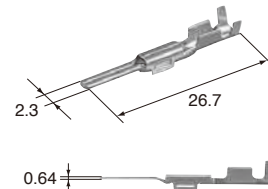
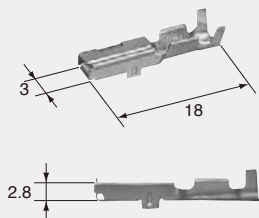
**M (8100-1341)****F (8100-1346)**

Cable size (mm ²) 適用電線サイズ	0.3~0.5
Material 材質	Brass 黄銅
Surface treatment 表面処理	Tin-plated Snメッキ

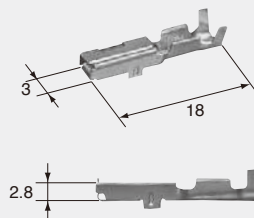

Cable size (mm ²) 適用電線サイズ	0.3~0.5
Material 材質	Brass 黄銅
Surface treatment 表面処理	Gold-plated Auメッキ

(M)

Cable size (mm ²) 適用電線サイズ	0.5~1.25
Material 材質	Brass 黄銅
Surface treatment 表面処理	Tin-plated Snメッキ

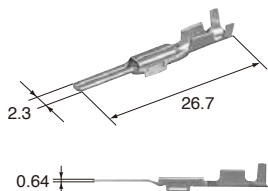
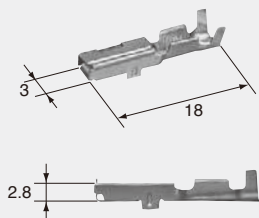
**M (8230-4502)****F (8240-4892)**

Cable size (mm ²) 適用電線サイズ	0.5~1.25
Material 材質	Brass 黄銅
Surface treatment 表面処理	Tin-plated Snメッキ

(M)**Au**

Cable size (mm ²) 適用電線サイズ	0.5~1.25
Material 材質	Brass 黄銅
Surface treatment 表面処理	Gold-plated Auメッキ

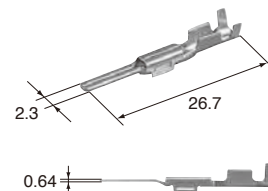
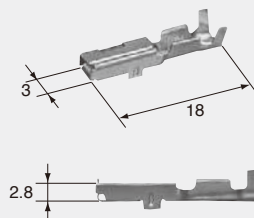
**M (8100-1342)****F (8100-1347)**

Cable size (mm ²) 適用電線サイズ	0.5~1.25
Material 材質	Brass 黄銅
Surface treatment 表面処理	Gold-plated Auメッキ

(L)

Cable size (mm ²) 適用電線サイズ	2.0
Material 材質	Brass 黄銅
Surface treatment 表面処理	Tin-plated Snメッキ

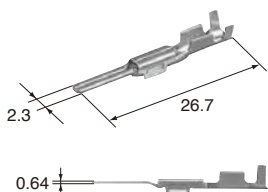
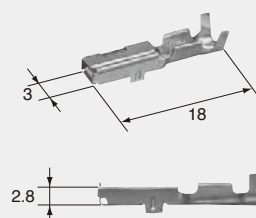
**M (8230-4512)****F (8240-4942)**

Cable size (mm ²) 適用電線サイズ	2.0
Material 材質	Heat-resistant copper alloy
Surface treatment 表面処理	Tin-plated Snメッキ

2.3mm (090)

Housing (UNIT : mm)

Ref: Terminal part No. A-10
ターミナル参照頁

2way

Material 材質	PA6T
Color 色相	Natural 自然色

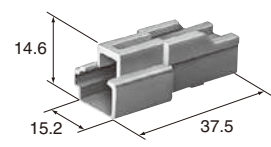

M (6520-0549) **F (6520-0550)**

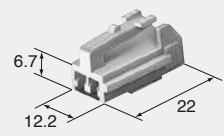

Material 材質	PA6T
Color 色相	Natural 自然色

6way

Material 材質	PBT
Color 色相	Natural 自然色
Note 備考	With clamp for 7mm dia. φ7用クランプ付

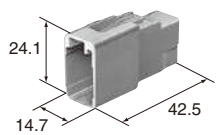

M (6240-1107)

Material 材質	PBT
Color 色相	Natural 自然色
Note 備考	With body fastening clamp. 回り止めクランプ付

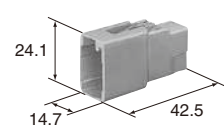

M (6249-1243) **F (6240-5118)**

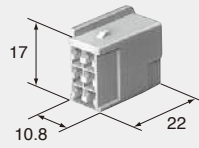

Material 材質	PBT
Color 色相	Natural 自然色

6way

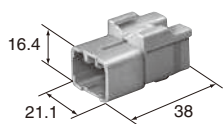

M (6240-1120)

Material 材質	PBT
Color 色相	Natural 自然色

9way

Material 材質	PBT
Color 色相	Natural 自然色

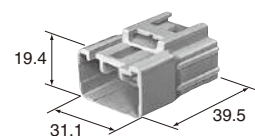

8way

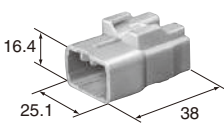

M (6240-1077)

Material 材質	PBT
Color 色相	Natural 自然色

M (6249-1229) **F (6248-5270)**

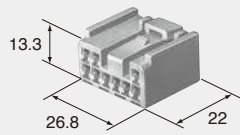

Material 材質	PBT
Color 色相	Natural 自然色

10way

Material 材質	PBT
Color 色相	Natural 自然色

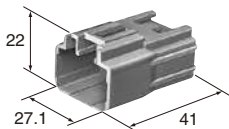

M (6249-1235)

F (6248-5276)

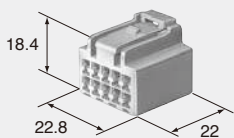

Material 材質	PBT
Color 色相	Natural 自然色

11way

Material 材質	PBT
Color 色相	Natural 自然色

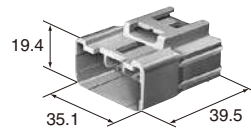

M (6249-1234)

F (6248-5275)

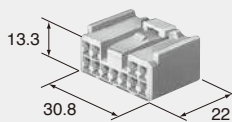

Material 材質	PBT
Color 色相	Natural 自然色

12way

Material 材質	PBT
Color 色相	Natural 自然色

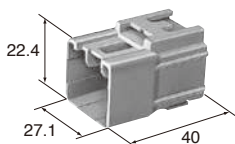

M (6520-1009)

F (6520-1004)

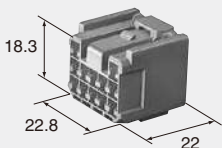

Material 材質	PBT
Color 色相	Natural 自然色

13way

Material 材質	PBT
Color 色相	Natural 自然色

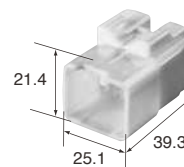

M (6240-1122)

F (6240-5175)

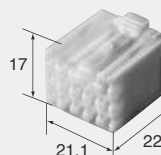

Material 材質	PBT
Color 色相	Natural 自然色

16way

Material 材質	PBT
Color 色相	Natural 自然色



M (6240-1158)

F (6240-5088)

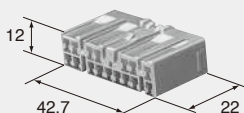

Material 材質	PBT
Color 色相	Natural 自然色

20way

Material 材質	PBT
Color 色相	Natural 自然色

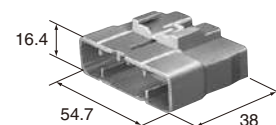

M (6240-1033)

F (6240-5035)

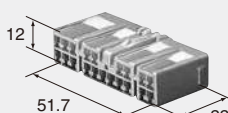

Material 材質	PBT
Color 色相	Natural 自然色